



COMF ELECTRONIC COMPANY

EXPORTERS, IMPORTERS & MANUFACTURERS

香港 九龍灣臨興街 32 號美羅中心 1 期 15 樓 11 室

Flat 11, 15/F, METRO CENTRE 1, 32 LAM HING ST.,

KOWLOON BAY, HONG KONG

TEL: (852) 2770 5181

WEB: www.comf-hk.com





FAX (852)2798 8129

Email: sales@comf-hk.com

Product Data Sheet SBH-331A



Specification

Cell Size:	3 X AA Cell, UM-3
Wire:	AWG 26, UL1007 150mm ± 5mm Stripped and Tinned: 5mm ±1mm
Body:	ABS 94HB, Black
Terminals:	0.3mm Nickel plated brass
Springs:	Ø0.5mm Nickel plated 65C spring steel
Compliance:	   



SBH-331A Shown without leads

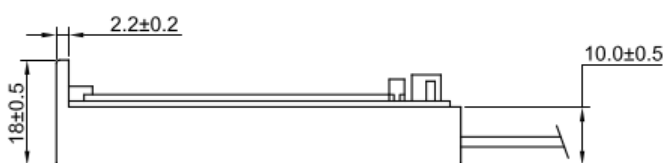
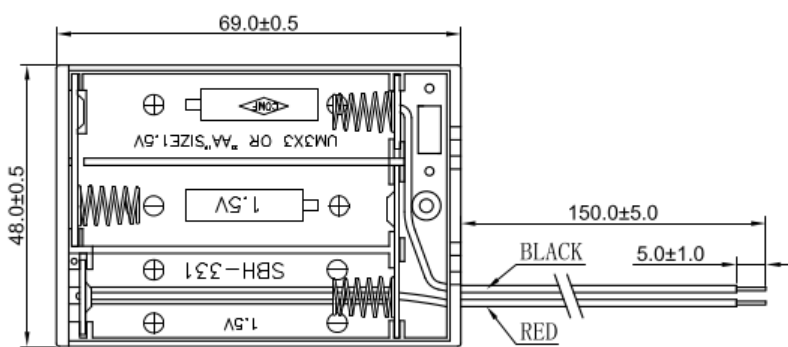

BOTTOM

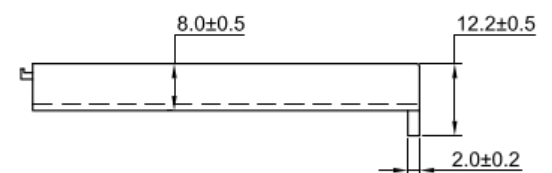
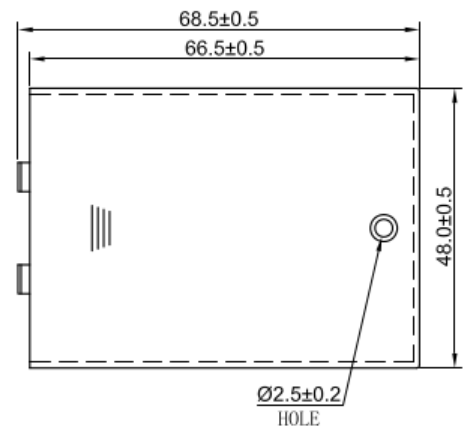

COVER