



# COMF ELECTRONIC COMPANY

EXPORTERS, IMPORTERS & MANUFACTURERS

香港 九龍灣臨興街 32 號美羅中心 1 期 15 樓 11 室

Flat 11, 15/F, METRO CENTRE 1, 32 LAM HING ST.,

KOWLOON BAY, HONG KONG

TEL: (852) 2770 5181

FAX (852)2798 8129



WEB: www.comf-hk.com

Email: sales@comf-hk.com

## Product Data Sheet BH-321-6B



### Specification

Cell Size:	2 X AA Cell, UM-3 <b>With Polarity Protection Posts</b>
Body:	Polypropylene, 94HB Black
Terminals:	Nickel plated brass
Springs:	Ø0.65mm Nickel plated spring steel
Compliance:	  



BH-321-6B Shown With Snap Terminals

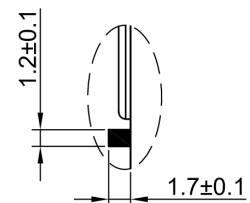
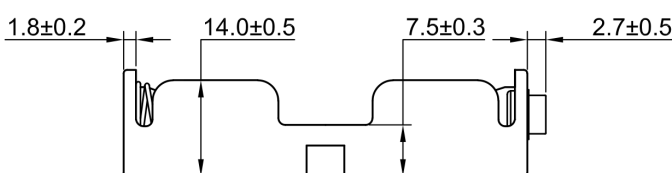
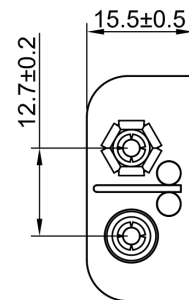
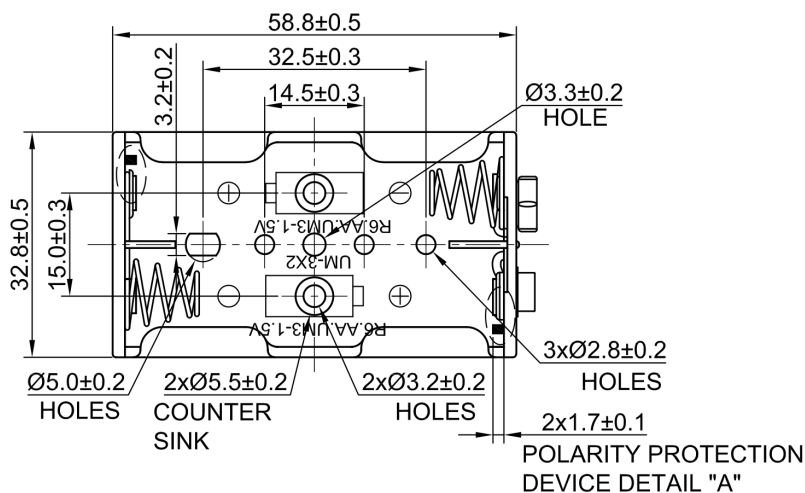

POLARITY PROTECTION DEVICE  
DETAIL "A" S=2